

# TTL-INTERFACED, GATED DELAY LINE OSCILLATOR (SERIES DLO31F)

**data  
delay  
devices, inc.**



## FEATURES

- Continuous or keyable wave train
- Synchronizes with arbitrary gating signal
- Fits standard 14-pin DIP socket
- Low profile
- Auto-insertable
- Input & outputs fully TTL interfaced & buffered
- Available in frequencies from 2MHz to 40MHz

## PACKAGES

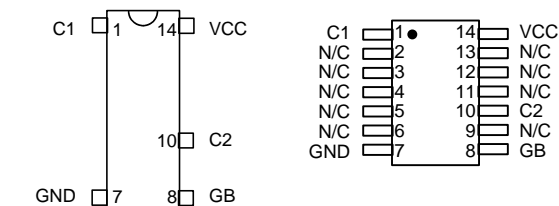

DLO31F-xx	DIP	Military SMD
DLO31F-xxA2	Gull-Wing	DLO31F-xxMD1
DLO31F-xxB2	J-Lead	DLO31F-xxMD4
DLO31F-xxM	Military DIP	

## FUNCTIONAL DESCRIPTION

The DLO31F-series device is a gated delay line oscillator. The device produces a stable square wave which is synchronized with the falling edge of the Gate Input (GB). The frequency of oscillation is given by the device dash number (See Table). The two outputs (C1,C2) are in phase during oscillation, but return to opposite logic levels when the device is disabled.

## PIN DESCRIPTIONS

GB	Gate Input
C1	Clock Output 1
C2	Clock Output 2
VCC	+5 Volts
GND	Ground

## SERIES SPECIFICATIONS

- **Frequency accuracy:** 2%
- **Inherent delay ( $T_{EO}$ ):** 5.5ns typical
- **Output skew:** 3.5ns typical
- **Output rise/fall time:** 2ns typical
- **Supply voltage:** 5VDC  $\pm$  5%
- **Supply current:** 40ma typical (7ma when disabled)
- **Operating temperature:** 0° to 70° C
- **Temperature coefficient:** 100 PPM/°C (See text)

## DASH NUMBER SPECIFICATIONS

Part Number	Frequency (MHz)
DLO31F-2	2.0 $\pm$ 0.04
DLO31F-2.5	2.5 $\pm$ 0.05
DLO31F-3	3.0 $\pm$ 0.06
DLO31F-3.5	3.5 $\pm$ 0.07
DLO31F-4	4.0 $\pm$ 0.08
DLO31F-4.5	4.5 $\pm$ 0.09
DLO31F-5	5.0 $\pm$ 0.10
DLO31F-5.5	5.5 $\pm$ 0.11
DLO31F-6	6.0 $\pm$ 0.12
DLO31F-7	7.0 $\pm$ 0.14
DLO31F-8	8.0 $\pm$ 0.16
DLO31F-9	9.0 $\pm$ 0.18
DLO31F-10	10 $\pm$ 0.20
DLO31F-12	12 $\pm$ 0.24
DLO31F-14	14 $\pm$ 0.28
DLO31F-15	15 $\pm$ 0.30
DLO31F-20	20 $\pm$ 0.40
DLO31F-25	25 $\pm$ 0.50
DLO31F-30	30 $\pm$ 0.60
DLO31F-35	35 $\pm$ 0.70
DLO31F-40	40 $\pm$ 0.80

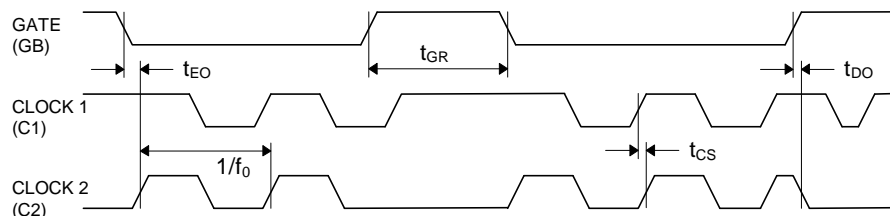

Figure 1: Timing Diagram

**NOTE:** Any dash number between 2 and 40 not shown is also available.

## APPLICATION NOTES

### THERMAL STABILITY

The delay line used internally to develop the clock signals in the DLO31F has a thermal coefficient of 100ppm/C. For low frequency units, this is also the thermal coefficient of the output frequency. For higher frequency units, however, other internal effects must be considered, and the actual thermal coefficient may be somewhat higher.

### POWER SUPPLY BYPASSING

The DLO31F relies on a stable power supply to produce a repeatable frequency within the stated tolerances. A 0.1uf capacitor from VCC to GND, located as close as possible to the VCC pin, is recommended. A wide VCC trace and a clean ground plane should be used.

## DEVICE SPECIFICATIONS

**TABLE 1: ABSOLUTE MAXIMUM RATINGS**

PARAMETER	SYMBOL	MIN	MAX	UNITS	NOTES
DC Supply Voltage	$V_{CC}$	-0.3	7.0	V	
Input Pin Voltage	$V_{IN}$	-0.3	$V_{DD}+0.3$	V	
Storage Temperature	$T_{STRG}$	-55	150	C	
Lead Temperature	$T_{LEAD}$		300	C	10 sec

**TABLE 2: DC ELECTRICAL CHARACTERISTICS**

(0C to 70C, 4.75V to 5.25V)

PARAMETER	SYMBOL	MIN	TYP	MAX	UNITS	NOTES
High Level Output Voltage	$V_{OH}$	2.5	3.4		V	$V_{CC} = \text{MIN}, I_{OH} = \text{MAX}$ $V_{IH} = \text{MIN}, V_{IL} = \text{MAX}$
Low Level Output Voltage	$V_{OL}$		0.35	0.5	V	$V_{CC} = \text{MIN}, I_{OL} = \text{MAX}$ $V_{IH} = \text{MIN}, V_{IL} = \text{MAX}$
High Level Output Current	$I_{OH}$			-1.0	mA	
Low Level Output Current	$I_{OL}$			20.0	mA	
High Level Input Voltage	$V_{IH}$	2.0			V	
Low Level Input Voltage	$V_{IL}$			0.8	V	
Input Clamp Voltage	$V_{IK}$			-1.2	V	$V_{CC} = \text{MIN}, I_I = I_{IK}$
Input Current at Maximum Input Voltage	$I_{IHH}$			0.1	mA	$V_{CC} = \text{MAX}, V_I = 7.0V$
High Level Input Current	$I_{IH}$			20	$\mu A$	$V_{CC} = \text{MAX}, V_I = 2.7V$
Low Level Input Current	$I_{IL}$			-0.6	mA	$V_{CC} = \text{MAX}, V_I = 0.5V$
Short-circuit Output Current	$I_{OS}$	-60		-150	mA	$V_{CC} = \text{MAX}$
Output High Fan-out				25	Unit	
Output Low Fan-out				12.5	Load	

**TABLE 3: AC ELECTRICAL CHARACTERISTICS**

(0C to 70C, 4.75V to 5.25V)

PARAMETER	SYMBOL	MIN	TYP	MAX	UNITS
Enable to Clock On (Inherent Delay)	$t_{EO}$	3.5	5.5	7.0	ns
Disable to Clock Off	$t_{DO}$	3.5	5.5	7.0	ns
Clock Skew	$t_{CS}$	2.5	3.5	4.5	ns
Gate Recovery Time	$t_{GR}$	50			% of Clock Period

**PACKAGE DIMENSIONS**

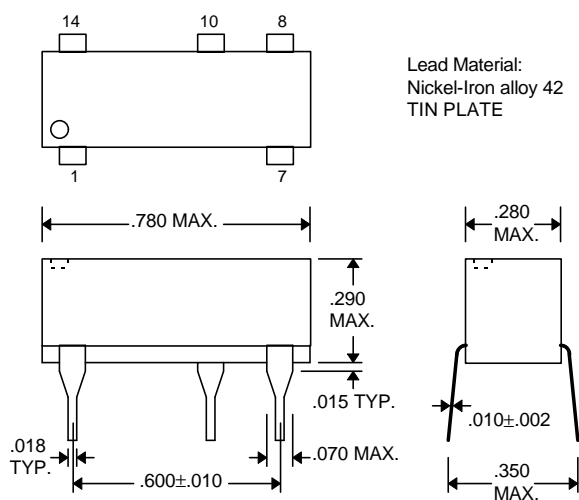

**DLO31F-xx (Commercial DIP)**

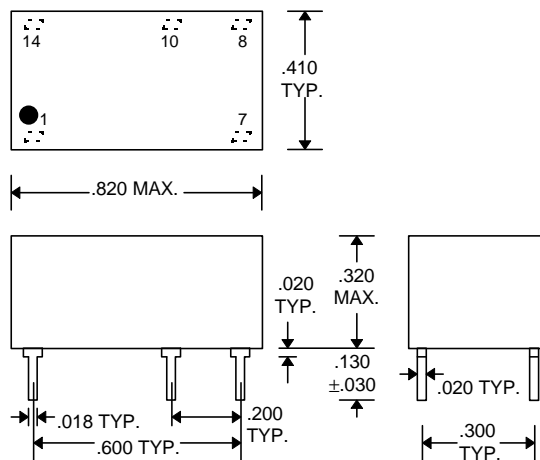

**DLO31F-xxM (Military DIP)**

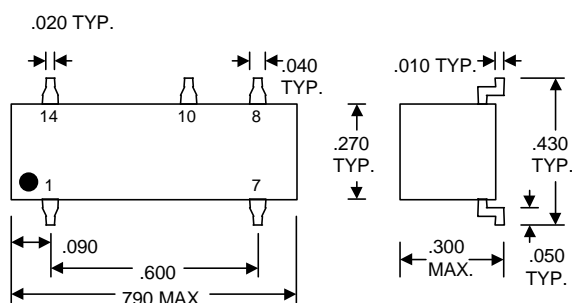

**DLO31F-xxA2 (Commercial Gull-Wing)**

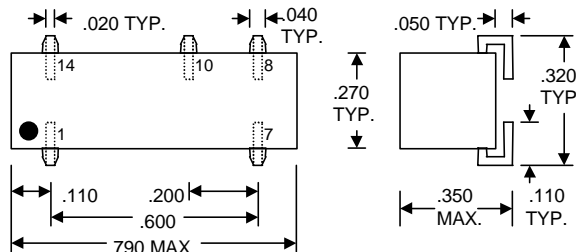

**DLO31F-xxB2 (Commercial J-Lead)**

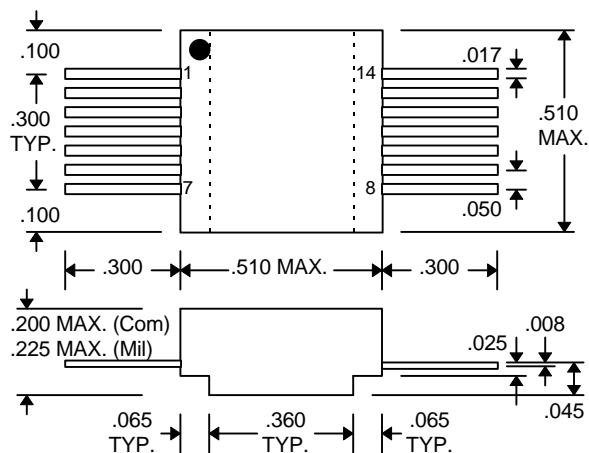

**DLO31F-xxD1 (Commercial SMD)  
DLO31F-xxMD1 (Military SMD)**

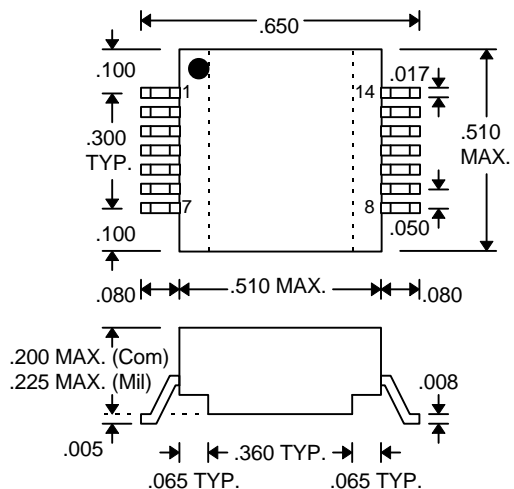

**DLO31F-xxD4 (Commercial SMD)  
DLO31F-xxMD4 (Military SMD)**

## DELAY LINE AUTOMATED TESTING

### TEST CONDITIONS

**INPUT:**

**Ambient Temperature:**  $25^{\circ}\text{C} \pm 3^{\circ}\text{C}$   
**Supply Voltage (Vcc):**  $5.0\text{V} \pm 0.1\text{V}$   
**Input Pulse:** High =  $3.0\text{V} \pm 0.1\text{V}$   
 Low =  $0.0\text{V} \pm 0.1\text{V}$   
**Source Impedance:**  $50\Omega$  Max.  
**Rise/Fall Time:**  $3.0\text{ ns Max. (measured between } 0.6\text{V and } 2.4\text{V)}$   
**Pulse Width Low:**  $\text{PW}_{\text{IN}} = 10 \times \text{Clock Period}$   
**Period:**  $\text{PER}_{\text{IN}} = 20 \times \text{Clock Period}$

**OUTPUT:**

**Load:** 1 FAST-TTL Gate  
**C<sub>load</sub>:**  $5\text{pf} \pm 10\%$   
**Threshold:** 1.5V (Rising & Falling)

**NOTE:** The above conditions are for test only and do not in any way restrict the operation of the device.

